



































PP 8 EXPO CE

| | REF | ART | COD |
|---|-----|-------------------------------------|---------|
|  | 02 | DECKEL FUER KARTOFFELSCHALMASCH. | RG04002 |
|  | 04 | KNOB FOR COVER_POTATO PEELER PP EX | RG04004 |
|  | 08 | FIXING SCREW FOR KNOB_P.PEELER EXPO | RG04008 |
|  | 12 | FAUCET FOR POTATO PEELER EXPO | RG04012 |
|  | 14 | RING - COVER POTATO PEELER PP8 | RG08014 |
|  | 16 | SIDE ABRASIVE PP 8 EXPO | RG08016 |
|  | 18 | CARASSA ACCIAIO INOX PLP EX 8 | RG08018 |
|  | 20 | NUT FOR POTATO PEELER EXPO | RG04020 |
|  | 22 | FIXING SCREW FOR PP EXPO | RG04022 |
|  | 24 | WASHER FOR PP EXPO | RG04024 |
|  | 25 | PEELING DISC FOR PP 4/8 EXPO | RG04025 |
|  | 30 | CONTROLS SUPPORT _ PP EXPO | RG04030 |
|  | 32 | DADO PLP EX | RG04032 |
|  | 34 | RONDELLA PLP EX | RG04034 |
| | 36 | FUORI PRODUZIONE-OUT OF PRODUCTION | 00-OUT |
|  | 38 | HANDLE SHAFT _ PP 8-15 EXPO | RG08038 |
|  | 40 | LEVER _ PP 8-15 EXPO | RG08040 |
|  | 42 | SHAFT _ PP EXPO | RG08042 |
| | 46 | FUORI PRODUZIONE-OUT OF PRODUCTION | 00-OUT |
|  | 48 | FLAT PLATE _ PP EXPO | RG08048 |
|  | 50 | DOOR _ PP 8-15 EXPO | RG08050 |
|  | 52 | DOOR GASKET _ PP 8 EXPO | RG08052 |
|  | 54 | MAGNETIC SENSOR _ PP 8-15 EXPO | RG08054 |
|  | 56 | SHAFT FOR PP EXPO | RG08056 |
|  | 58 | WASHER | RG04058 |

PLATON SERVICE
 8(800) 500 3447
 www.platonservice.com

| | | | |
|---|-----|-------------------------------------|-----------|
|  | 60 | SCREW | RG08060 |
|  | 62 | SCREW | RG04062 |
|  | 64 | WASHER | RG04064 |
|  | 68 | SCREW | RG08068 |
|  | 70 | SCREW | RG04070 |
|  | 74 | FOOT BASE - PP4/PP8 | RG04074 |
|  | 76 | PIEDINI CON ALETTA PLP EX 4/8 | RG04076 |
|  | 80 | PIEDINI PLP EX 4/8 | RG04080 |
|  | 82 | FONDO PLP EX 4/8 | RG04082 |
|  | 84 | DRAIN PIPE FOR POTATO PEELER EXPO | RG04084 |
|  | 90 | SCREW | RG04090 |
|  | 92 | FASCIA LATERALE PLP EX 8 | RG08092 |
|  | 94 | MICROSWITCH FOR PP EXPO | RG04094 |
|  | 96 | SCREW | RG04096 |
|  | 98 | NUT | RG04098 |
|  | 112 | FIXING SCREW FOR COVER_P.PEELER EXP | RG04112 |
|  | 114 | FIX.WASHER FOR COVER_P.PEELER EXPO | RG04114 |
|  | 120 | FIXING NUT FOR HINGE_P.PEELER EXPO | RG04120 |
|  | 122 | FIXING SCREW FOR MAGNET_P.PEELER EX | RG04122 |
|  | 124 | FIX.WASHER FOR MAGNET_P.PEELER EXPO | RG04124 |
|  | 126 | MAGNET-HOLDER FOR POTATO PEELER EX | RG04126 |
|  | 128 | MAGNETE X BOCCA ATHOS | IV5823050 |



8 (800) 500-3447
www.platonservice.com

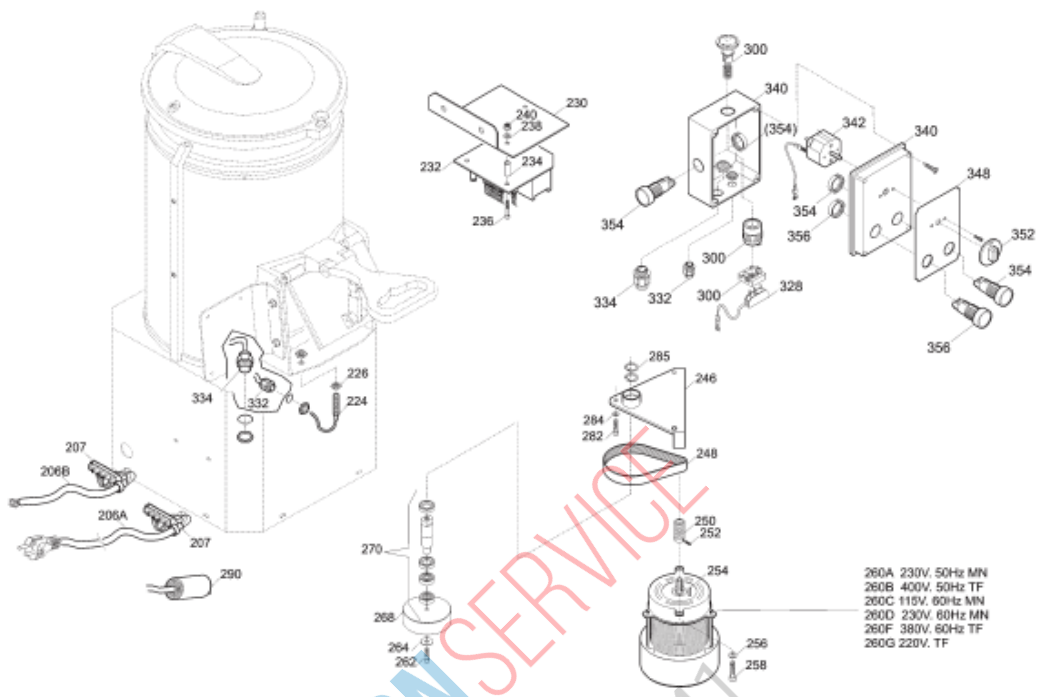

















- 260A 230V 50Hz MN
- 260B 400V 50Hz TF
- 260C 115V 60Hz MN
- 260D 230V 60Hz MN
- 260F 380V 60Hz TF
- 260G 220V TF















PLATON SERVICE
 8 (800) 500-34-41
 www.platonservice.com

PP 8 EXPO CE

| | REF | ART | COD |
|---|------|-------------------------------------|----------|
|  | 206A | 1-PH POWER CORD FOR P.PEELER EXPO | RG04206A |
|  | 206B | CAVO ALIMENTAZIONE TF PLP EX | RG04206B |
|  | 207 | MORSETTIERA CORTA PLP EX | RG04207 |
|  | 224 | MAGNETIC MICROSWITCH PPEXPO | RG04224 |
|  | 226 | NUT FOR MICROSWITCH | RG04226 |
|  | 230 | SUPPORTO SCHEDA COMANDO PLP EX | RG04230 |
|  | 232 | CIRCUIT BOARD 220/50 _ PP4-8-15 EXP | RG04232 |
|  | 234 | SPACER PP 4-8-15 EXPO | RG04234 |
|  | 236 | FIXING SCREW PP 4-8-15 EXPO | RG04236 |
|  | 238 | RONDELLA PLP EX | RG04238 |
|  | 240 | DADO PLP EX | RG04240 |
|  | 246 | MOTOR SUPPORT FOR PP 8 EXPO | RG08246 |
|  | 248 | RIEMEN FUER KARTOFFELSCHALER | RG08248 |
|  | 250 | PULLEY_SMALL PP 8 EXPO | RG08250 |
|  | 252 | PULLEY INSERT PP 8 EXPO | RG08252 |
|  | 254 | MOTOR INSERT PP 8 EXPO | RG08254 |
|  | 256 | WASHER FOR PP 4-8 EXPO | RG04256 |
|  | 258 | SCREW FOR PP 4-8 EXPO | RG04258 |
|  | 260C | MOTORE MN 115V/60 HZ PLP EX 8 | RG08260C |
|  | 260A | MOTOR 230/50/1 FOR PP 8 EXPO | RG08260A |
|  | 260D | MOTOR 230/60/1 FOR PP8 | RG08260D |
|  | 260G | MOTORE TF 220 PLP EX 8 | RG08260G |
|  | 260F | MOTORE TF 380V/60 HZ PLP EX 8 | RG08260F |
|  | 260B | MOTOR 400V/50 HZ FOR PP 8 EXPO | RG08260B |

PLATON SERVICE
 (800) 500-5247
 www.platonservice.com

| | | | |
|---|-----|------------------------------------|-----------|
|  | 262 | SCREW FOR PP 8 EXPO | RG08262 |
|  | 264 | WASHER FOR PP 8 EXPO | RG08264 |
|  | 268 | PULLEY FOR PP 8 EXPO | RG08268 |
|  | 270 | MITNEHMER SCHLEIFSCHEIBE PP8-15EX | RG08270 |
|  | 282 | VITE PLP EX 8 | RG08282 |
|  | 284 | RONDELLA PLP EX 8 | RG08284 |
|  | 285 | INNEURING FUER AUFSCH. | 19330301 |
|  | 290 | KONDENSATOR PP8-15EXPO | RG08290 |
|  | 300 | EMERGENCY STOP BUTTON FOR BONE SAW | LF1034002 |
|  | 328 | EMERGENCY BUTTON CONTACT P/PEELER | RG04328 |
|  | 332 | STRAIN RELIEF FOR POTATO PEELER | RG04332 |
|  | 334 | STRAIN RELIEF FOR POTATO PEELER | RG04334 |
|  | 340 | PCB BOX FOR POTATO PEELER | RG04340 |
|  | 342 | TIMER+KNOB FOR PP EXPO | RG04342 |
|  | 348 | BUTTON TIMER FOR POTATO PEELER | RG04348 |
|  | 352 | TIMERGRIFF PP EXPO | RG04352 |
|  | 354 | STOP BUTTON _ SO/TC | LF1010705 |
|  | 356 | ON BUTTON _ SO/TC 22-32/P | LF1034001 |



PLATON SERVICE

8 (800) 500-3441

www.platonservice.com